

# MegaPX WDR MiniDome Z2

Indoor IP dome available in 1MP  
and 2MP resolution



Side cable access housing



For cost-conscious customers ready to start migrating to the IP camera world, the **MegaPX WDR MiniDome Z2** delivers IP video capabilities, and an upgrade from standard definition to high definition video, at an exceptional price. It offers all the advantages of an IP camera — like alarms, audio and intelligent video — along with exceptional image quality in all lighting conditions.

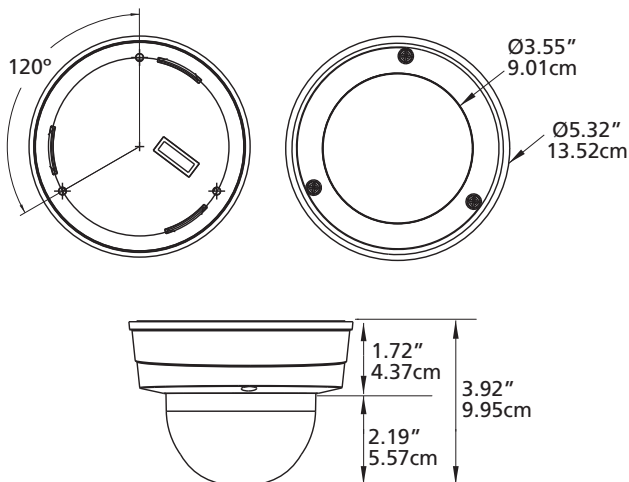

## Key Benefits

- ▼ **Choose the resolution that's right for you.** The camera is available in 1080p and 720p versions, depending on your surveillance requirements.
- ▼ **True Day/Night (TDN).** When lighting conditions get too dark, the camera will automatically switch from color to black and white, allowing you to discern details in almost complete darkness.
- ▼ **3-axis gimbal.** The camera's pan, tilt and rotation are adjusted by a single mechanism. This allows for single-handed positioning of the camera during installation and simplifies setup.
- ▼ **EMT mount available.** Because this mount accommodates pipes without threading on them, you won't need a pipe threader on-site to mount this camera, making it cheaper and faster to install.
- ▼ **Privacy masks.** The ability to conceal parts of the image from view with a masked area comes standard with this camera.
- ▼ **Multiple mounting options.** There are mounts available for any application, including wall, pole, corner, electrical plate, and side cable access housing for surface mounting.









*Get superior coverage indoors, even in bright areas like atriums and lobbies, at an economical price.*

# MegaPX WDR MiniDome Z2

CAMERA	
<b>Image Sensor</b>	1/2.7" CMOS progressive scan
<b>Lens</b>	3-10.5mm, F1.2, DC iris, remote zoom/focus, Angle of view: 30°–100°(horizontal)
<b>Minimum Illumination</b>	Color: 0.6 lux @ F1.2 (30IRE, AGC on) B/W: 0.01 lux @ F1.2 (30IRE, AGC on)
<b>Wide Dynamic Range</b>	100dB
<b>Shutter Time</b>	1/25 to 1/10000 sec
<b>Camera Angle Adjustment</b>	Pan 360°, Tilt 156°, Rotation 360°
VIDEO	
<b>Video Compression</b>	H.264, M-JPEG
<b>Resolution: 31571</b>	1080p (1920x1080) to CIF (352x288)
<b>31571-SD</b>	720p (1280 x 720) to CIF (352x288)
<b>Frame Rate: 31571</b>	Up to 30 fps @ 1080p
<b>31571-SD</b>	Up to 30 fps @ 720p
<b>Video Streaming</b>	Dual-stream H.264 and M-JPEG (1080p or 720p on stream 1; D1 or 720p on stream 2) Controllable frame rate and bandwidth CBR/VBR H.264; VBR M-JPEG (quality settings)
<b>Image Settings</b>	Wide dynamic range, anti-flicker, white balance mode, brightness, contrast, saturation, hue, sharpness, mirror mode, privacy masks, motion detection

AUDIO	
<b>Audio Streaming</b>	Two way
<b>Audio Compression</b>	G.711 PCM, G.726 ADPCM, configurable bit rate
<b>Audio Input/Output</b>	Stereo line in, stereo line out

NETWORK	
<b>Security</b>	Password protection, IP address filtering, connection management, LDAP authentication, HTTPS encryption (configuration only)
<b>Supported Protocols</b>	ONVIF S, RTP, RTSP, RTCP, HTTP, HTTPS, IPv4, TCP, UDP, DHCP, ARP, LDAP, 802.1X

MOUNTING OPTIONS		
 Indoor Flush Mount Adaptor	 1.5" NPT Mount Adaptor	 0.75" EMT Mount Adaptor
 1.5" NPT Pendant Mount	 1.5" NPT Wall Mount	 Pole Adaptor
 Indoor Electrical Plate Adaptor (Surface)	 Side Cable Access Housing	 Corner Adaptor

SYSTEM INTEGRATION	
<b>Intelligent Video</b>	Video motion detection, active tampering
<b>Alarm Triggers</b>	Video motion detection, active tampering, external input
<b>Alarm Events</b>	Video recording to local storage (microSDHC); external output activation
GENERAL	
<b>Housing</b>	Light-weight, durable, indoor plastic housing
<b>Power</b>	Power over Ethernet IEEE 802.3af Class 0
<b>Connectors</b>	Female RJ-45 100BASE-TX PoE, 1 alarm input, 1 alarm output, audio line in, audio line out
<b>Local Storage</b>	microSDHC memory card (not included)
<b>Operating Conditions</b>	14 to 122°F / -10 to 50°C, 0–90% relative humidity non-condensing
<b>Regulatory Approvals</b>	CE – EMC Directive; 2004/108/EC; Standards EN55022; EN55024; FCC Part 15 Subpart B; ICES-003; UL-60950-1; ROHS2 (2011/65/EU); C-Tick; EN61000-3-2; WEEE
<b>Mechanical Weight</b>	1.1 lb / 0.5 kg
<b>Dimensions (HxD)</b>	3.92 x 5.32 in. / 9.95 x 13.52 cm
<b>Included Accessories</b>	Software CD (including Installation Guide and User Manual, March Networks SiteManager, and Browser), mounting template

ORDERING INFORMATION	
<b>DOME</b>	
31571	2MP
31571-SD	1MP
<b>MOUNTS</b>	
28319	Indoor Flush Mount Adaptor
30327	1.5" NPT Mount Adaptor
29079	0.75" EMT Mount Adaptor
HOMINIDOMESMA	Pendant Mount
HOMINIDOMEWB	Wall Mount
HOMINIDOMEPPMA	Pole Adaptor
28317	Indoor Electrical Plate Adaptor (Surface)
30323	Side Cable Access Housing
27639	Corner Adaptor
27392	Tinted Bubble (10 Pack)

North America . . . . . 1 800 563 5564  
 Latin America . . . . . +5255 5259 9511  
 Europe . . . . . +39 0362 17935  
 Asia . . . . . +65 6818 0963  
 Australia and New Zealand . . . . . +61 1300 089 419  
 Middle East and Africa . . . . . +971 4 399 5525

© 2017, March Networks, An Infinova Company. All rights reserved. Information in this document is subject to change without notice. MARCH NETWORKS, March Networks Command, March Networks Searchlight, March Networks RideSafe, and the MARCH NETWORKS logo are trademarks of March Networks Corporation. Infinova is a trademark of Infinova Corporation. All other trademarks are the property of their respective owners. 060-3160-00-I [marchnetworks.com](http://marchnetworks.com)

